



Sirocco 30 / Chinook 30 / Ashford 30

# **BLAZE KING** 30 Series

## Free Standing Wood Stoves



Blaze  King  
[www.blazeking.com](http://www.blazeking.com)



Sirocco 30 with Pedestal, Ash Drawer, painted Cast Iron Door, and Standard Convection Deck.



Pedestal Ash Drawer



Cast Iron Door with Optional Satin Trim and Handle



# SIROCCO 30

**Classic Lines and Versatility** The Sirocco series embodies the timeless styling of the North American wood stove.

**Customize** You can customize your Sirocco 30 to match the decor of your home by choosing either the Pedestal or Cast Leg version. You can complete your styling preferences by choosing the available Satin Trim accents.

**Correct Firebox Size** It is important to pick the correct stove size to heat your home. At 2.9 cu. ft. the Sirocco, Chinook, and Ashford 30 have larger sized fireboxes. All Blaze King catalytic stoves are thermostatically controlled which allows you to regulate the heat output, making them usable in a wide variety of home sizes.



Sirocco 30 with Cast Iron Legs, painted Cast Iron Door, optional Ash Drawer, and Standard Convection Deck

Specifications: Sirocco 30.2	Real World Tested Performance (HHV)
Cord Wood Max BTU**	50,000 BTU's
Efficiency	76%
Maximum Heat Input*	472,183 BTU's
Constant Heat Output on High*	35,980 BTU's/hour up to 10 hours
Constant Heat Output on Low*	11,993 BTU's/hour up to 30 hours
Square Feet Heated	1100 - 2400
Maximum Log Size	Up to 19"
Recommended Log Length	18"
Average Heating Time*	8 to 13 hours
Potential Burn Time on Low*	30 hours
Emissions (grams/hour)	0.8 g/hr
Firebox Size	2.9 cu.ft.
Flue Size	6"
CO (g/min)	0.71
** Cord Wood BTU is calculated using the cord wood test method. * BTU, heat input and output and heating times depend on influences such as home size, home insulation, installation configuration, wood species, wood content and climatic conditions.	



Chinook 30 with Standard Metallic Black Sides and Standard Ash Drawer

## CHINOOK 30

**Design** The Chinook 30 has a modern European design with curved sides for a unique, soft appearance that will suit the decor of any modern home. The Standard Ash Drawer is mounted on specially engineered runners that provide a smooth, gliding action. The Chinook 30, Sirocco 30, and Ashford 30 are amongst the cleanest wood stoves available at 0.80 g/hr particulate emissions. Their 2.9 cu. ft. firebox is capable of burning for up to 30 hours on low.



Cast Iron Convection Air Grille



Satin Bypass Handle



Ash Drawer on Easy Glide runners with removable Ash Pan



Satin Door Handle



Chinook 30  
Standard  
Metallic Black

Specifications: Chinook 30.2	Real World Tested Performance (HHV)
Cord Wood Max BTU**	50,000 BTU's
Efficiency	76%
Maximum Heat Input*	472,183 BTU's
Constant Heat Output on High*	35,980 BTU's/hour up to 10 hours
Constant Heat Output on Low*	11,993 BTU's/hour up to 30 hours
Square Feet Heated	1100 - 2400
Maximum Log Size	Up to 19"
Recommended Log Length	18"
Average Heating Time*	8 to 13 hours
Potential Burn Time on Low*	30 hours
Emissions (grams/hour)	0.8 g/hr
Firebox Size	2.9 cu.ft.
Flue Size	6"
CO (g/min)	0.71

\*\* Cord Wood BTU is calculated using the cord wood test method.  
\* BTU, heat input and output and heating times depend on influences such as home size, home insulation, installation configuration, wood species, wood moisture content and climatic conditions.



Ashford 30 Metallic Black Paint



Ash Drawer on Easy Glide Runners with removable Ash Pan



Burled walnut door handle with satin plated inset



Ornate leg detail

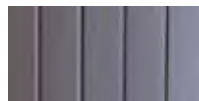

Cast Gray Paint



Metallic Black Paint



Chestnut Brown Porcelain Enamel





# ASHFORD 30

**Design** Our craftsmen used the timeless medium of cast iron to create a beautiful and elegant piece of furniture with detailed relief and curves. The Ashford is available in: Metallic Black or Cast Gray paint finishes and Chestnut Brown Porcelain Enamel finish.

Burled walnut is carved for the door and bypass handles. This creates a luxurious feel every time you use your stove. The adjustable, dual action door latch has a positive lock feel and is easy to operate.

The attention to detail is evident on the Ashford 30. For example, the Standard Ash Drawer is mounted on Easy Glide runners with a removable Ash Pan and Lid for smooth refined operation.

Specifications: Ashford 30.2	Real World Tested Performance (HHV)
Cord Wood Max BTU**	50,000 BTU's
Efficiency	76%
Maximum Heat Input*	472,183 BTU's
Constant Heat Output on High*	35,980 BTU's/hour up to 10 hours
Constant Heat Output on Low*	11,993 BTU's/hour up to 30 hours
Square Feet Heated	1100 - 2400
Maximum Log Size	Up to 19"
Recommended Log Length	18"
Average Heating Time*	8 to 13 hours
Potential Burn Time on Low*	30 hours
Emissions (grams/hour)	0.8 g/hr
Firebox Size	2.9 cu. ft.
Flue Size	6"
CO (g/min)	0.71

\*\* Cord Wood BTU is calculated using the cord wood test method.  
 \* BTU, heat input and output and heating times depend on influences such as home size, home insulation, installation configuration, wood species, wood moisture content and climatic conditions.



Ashford 30 Cast Gray Paint



Ashford 30 Chestnut Brown Porcelain Enamel

## Clearances – Sirocco 30.2, Chinook 30.2 and Ashford 30.2

### Minimum Clearance to Combustibles (See owner's manual for complete list prior to install)

A – Side Wall to Side of Unit	10¾"
B – Rear Wall to Back of Unit	6"
E – Adjacent Wall to Corner of Unit	4"
J – Minimum Alcove Height	72"
K – Horizontal Flue to Ceiling (USA)	18"
L – Center of flue to edge of door opening	15¾"

(In Canada, if K=18", then J=49")

### Hearth Protection

G – Edge of Hearth Pad to Side of Unit (USA)	Chinook 3" (USA)	5 <sup>5</sup> / <sub>8</sub> " (Canada)
	Sirocco 3¾" (USA)	4¾" (Canada)
	Ashford 3" (USA)	5 <sup>5</sup> / <sub>8</sub> " (Canada)
H – Door opening to edge of ember protection	16" (USA)	18" (Canada)
I – Rear of stove to edge of ember protection	0" (USA)	8" (Canada)

\*Mobile Home: Must use Fan Kit or Rear Shield & Double Wall Pipe and Fresh Air Intake Kit  
 \*Check Local Codes/Pipe Manufacturer Requirements for Clearances. In all of Canada and most of USA, 18" Clearances from single Wall Pipe are required.

## Options

### Sirocco Options

- Pedestal with Ash Drawer
- Cast Iron Legs
- Ash Drawer for Leg Model
- Cast Iron Door
- Cast Iron Door with Satin Trim
- Dual Fan Kit
- Fresh Air Kit
- Rear Heat Shield

### Chinook Options

- Dual Fan Kit
- Rear Heat Shield
- Fresh Air Kit

### Ashford Options

- Choice of colors - Metallic Black Paint, Cast Gray Paint, Chestnut Brown Porcelain Enamel
- Dual Fan Kit
- Fresh Air Kit

## Clearances

### Sirocco 30.2

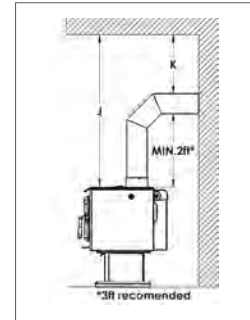
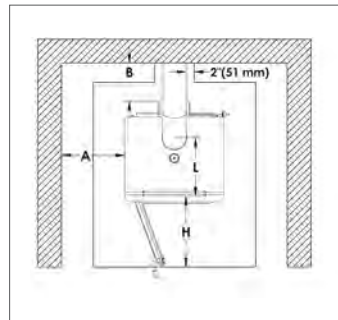
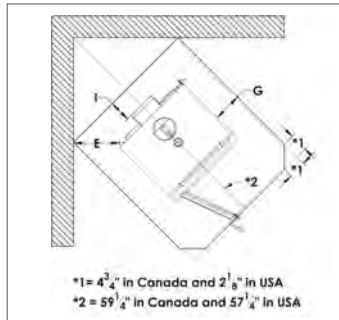

### Chinook 30.2

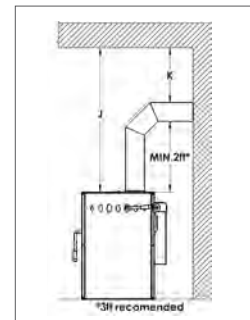
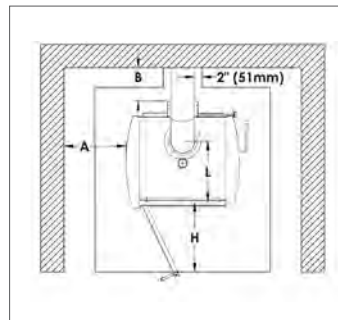
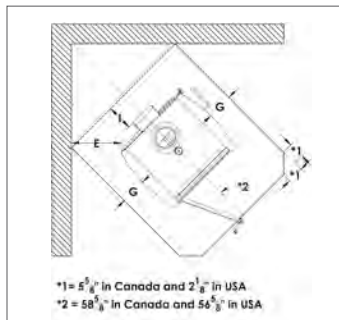

### Ashford 30.2

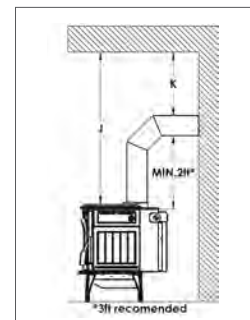
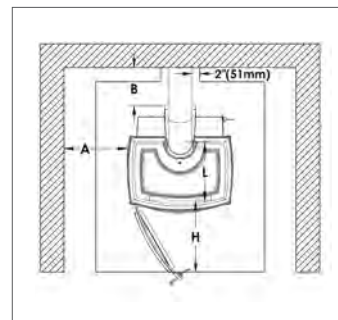
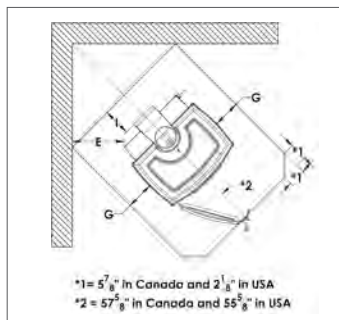



# Blaze King 30 Series Specifications

## Dimensions

**Sirocco 30.2**

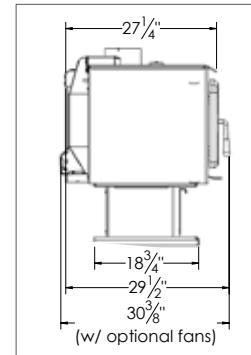
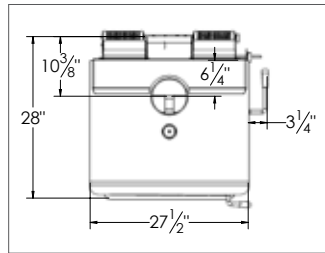
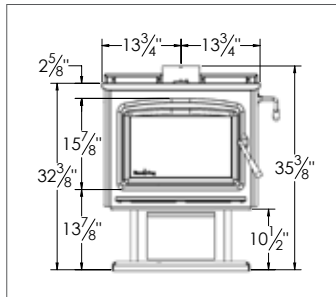

**Chinook 30.2**

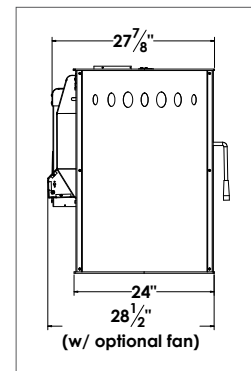
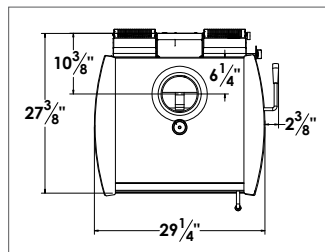
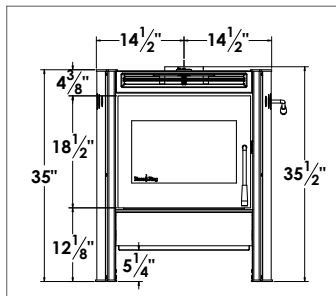

**Ashford 30.2**

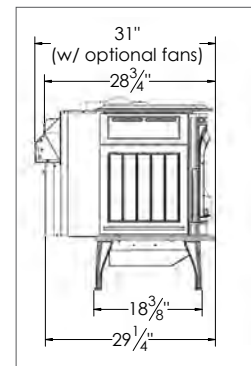
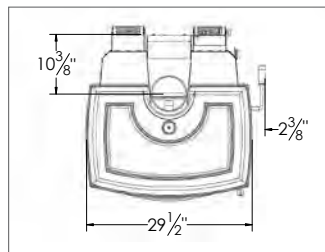
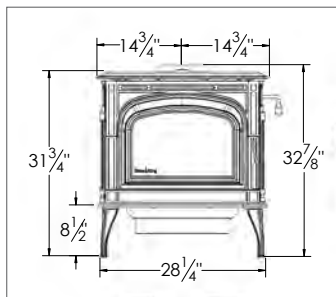

### Specifications – Sirocco 30.2, Chinook 30.2 and Ashford 30.2

Heating capacity - Sq. ft.	1,100 to 2,400
Wood length	19" (recommended 18")
Wood capacity (soft wood) - Lbs.	40
Wood capacity (hard wood) - Lbs.	60
Flue size	6"
Door opening	18 <sup>5</sup> / <sub>8</sub> " x 9 <sup>7</sup> / <sub>8</sub> "
Firebox depth (front to back)	18" (brick to brick); 20½" (brick to glass)
Firebox width	20"
Firebox height	12 <sup>7</sup> / <sub>8</sub> "
Firebox capacity - Cu. ft.	2.9
Emissions - Grams/hour	0.80
Maximum heat input*	472,183 BTU's
Heat output on high*	35,980 BTU's/hour for 10 hours
Low burn time*	Up to 30 hours
High burn time*	Up to 10 hours
Max crib fuel test BTUs	27,116
Max Cord Wood test BTUs	50,000
Approximate weight – Sirocco	415 lbs. on pedestal, 385 lbs. on legs
Approximate weight – Chinook	450 lbs.
Approximate weight – Ashford	513 lbs.



\* Heating capacity is determined by geographic location and actual heat loss calculation of the dwelling.

### Burn Chart: Ashford, Sirocco, Chinook

The graph below shows the results of a test run by Blaze King Industries, Inc. on a Chinook 30. The lines on the graph represent how the stove performed during the test. The recordings were started when the combustor reached 800° F. The firebox was loaded with 58 lbs. of Western Larch. The thermostat was closed down to a low setting and the test was run on that single load.

**A**—The Blue line shows the weight of the wood or stored energy/potential

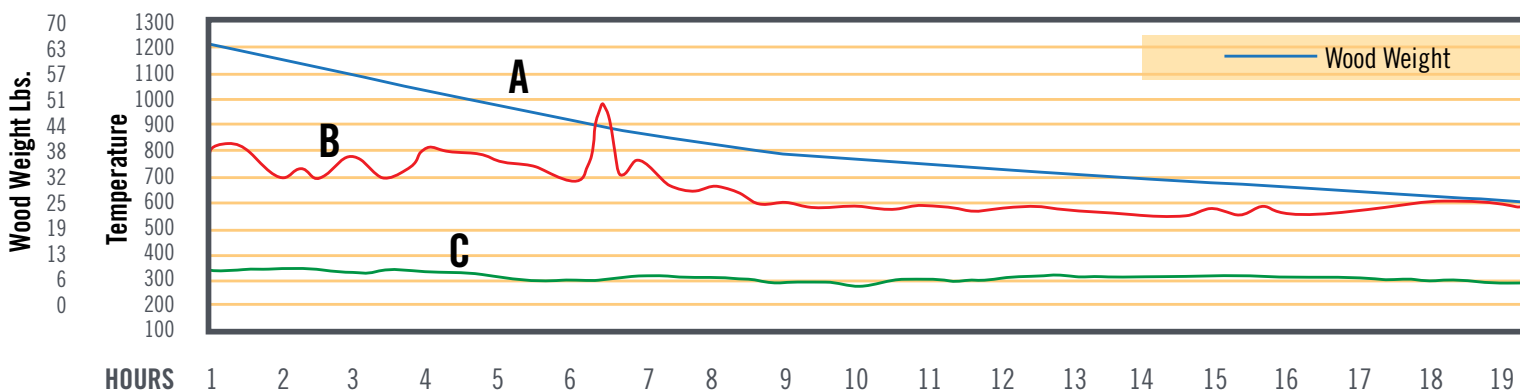

heat. The reduction in the weight of the wood load is greatest in the beginning as the moisture is boiled out of the wood. The blue line shows a very gradual & even reduction in the weight demonstrating the even heat output you can expect from a Blaze King catalytic wood stove.

**B**—The Red line shows the temperature of the catalyst as it captures the energy that would normally escape up the flue in ordinary wood stoves. Twenty four hours into the burn, the wood collapses, releasing previously unburned gases and smoke. This release of energy increases firebox temperatures and supplies more fuel to the catalyst. Note the thermostat

# Blaze King 30 Series Specifications

## The Benefits of Owning a Blaze King

**Bio Energy** By using renewable wood fuel in your clean burning Blaze King, you are reducing your output of fossil fuel emissions and your impact on the environment. Our stoves merely release the amount of CO<sup>2</sup> that a tree would absorb over its lifespan. Blaze King stoves are amongst the cleanest and most efficient stoves available.

**Radiant Heat and Convection Heat** The Sirocco, Chinook, and Ashford deliver the same amount of heat and have the same efficiencies. Each model delivers the same efficient warmth but does so in different ways.

The Sirocco has a ¼" plate steel top for the firebox/stove, that is in direct contact with the room air. Soon after a fire is established, the surface of the stove heats up and quickly radiates the heat to the room.

The Chinook is built with a second layer of steel surrounding the firebox. This layer helps channel the convection air over the firebox to the front of the stove. The air becomes super heated as it is in contact with the firebox for a longer period of time, thus removing more of the heat through the convection process. As the second layer is heated it will radiate its stored energy back into the room.

The Ashford has a second layer of cast iron surrounding the firebox. The convection air is super heated as it is channeled over the firebox for a longer time. The cast iron layer takes time to heat up. After it is heated it is very efficient at retaining this heat and radiating it back into the room over an extended period of time.

**Long Burn Times** The 30 size firebox is capable of burning for up to 30 hours when conditions allow. In the real world the most important thing is to get over-night heat. By pushing the boundaries of long burn times Blaze King is able to deliver that all-important night's sleep. The 30 firebox can deliver a heating time of 12 to 16 hours even in the coldest of climates.

**Efficiencies** The true efficiency for a wood stove is the number published by the US Environmental Protection Agency (EPA) on its web site. When comparing efficiencies of different brands you should always compare the EPA "Actual Measured Efficiency" (HHV) and not the Optimum or Low Heat Value (LHV) number quoted by most manufacturers on their brochures. The LHV is not representative of how a stove performs in your home. The EPA actual measured efficiency (HHV) number is a true reading of how your stove performs in the real world. Blaze King builds the 1st and 2nd most efficient stoves sold in North America as listed by the EPA. Follow the link to the EPA web site for confirmation at: <http://www.epa.gov/Compliance/resources/publications/monitoring/caa/woodstoves/certifiedwood.pdf>. All Blaze King stoves show efficiencies from the mid 70 percentile up to 81%, the highest certified efficiency of any wood stove.

responds, controlling the air intake to the fire, automatically maintaining the desired & prescribed low burn setting.

**C**—The Green line shows the flue temperature. The interaction of the combustor and the automatic thermostat makes your Blaze King one of the most efficient wood stoves in the world. The proof is in our flue temperatures. Ordinary stoves have flue temperatures of between 600° F and 900° F while your Blaze King flue temperature remains around 300° F. Ordinary stoves lose valuable heat up the flue. Blaze King catalytic stoves keep the heat in the home saving money and work. By making your stove

this efficient you will burn up to 33% less wood. This is a major advantage that only a Blaze King offers.

Note: After 37 hours of continuous burning, the combustor temperature starts to fall below 550° F having run out of fuel (gases) and becomes inactive. The fire is not completely out as there is still a hot bed of coals in the stove ready to ignite the next load of wood.

For additional information on burning your Blaze King wood stove go to [www.blazeking.com](http://www.blazeking.com).

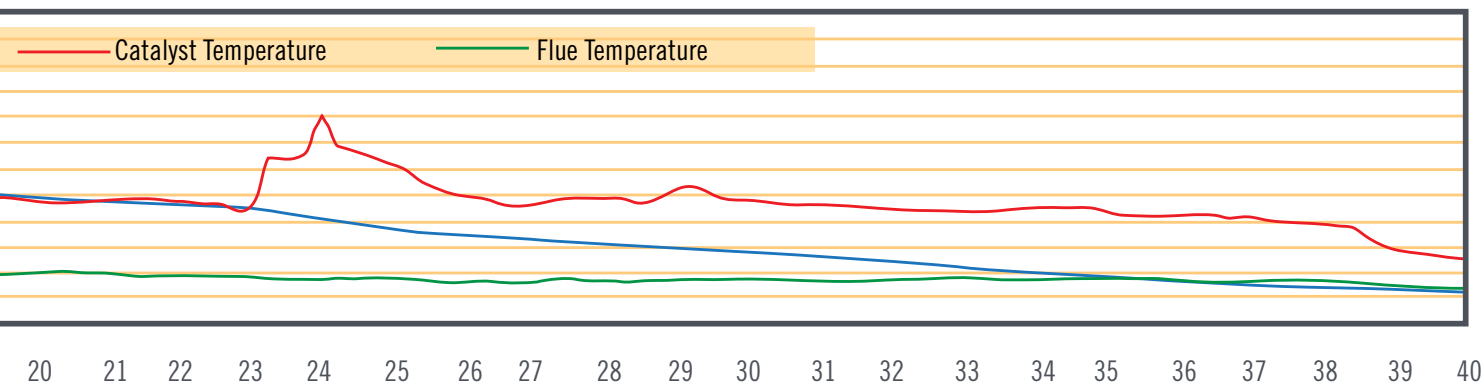

# BLAZE KING

## Sirocco 30, Chinook 30, Ashford 30 Features

**Catalytic Technology** Blaze King has been making large wood stoves for 35 years. Over this time period we have built a tradition of craftsmanship and performance that is unequalled. In 1983 Blaze King invented the first hybrid wood stove using air tubes and a catalytic converter. A year later Blaze King received the first certificate of compliance, number 001, for the first clean burning wood stove in North America. We received this certificate from the Oregon Department of Environmental Air Quality which was a forerunner to today's regulatory body, the EPA. A refined version of this technology is what you see in every catalytic Blaze King today.

**Thermostat control (No electricity required)** Blaze King's built-in thermostat constantly monitors the heat output of your stove. It automatically adjusts the air required for combustion. This unique technology, where we combine the efficiencies of a catalytic combustor with a built-in thermostat, provides the longest burn times of any wood stove. You get a full night's sleep without having to reload your stove. It also means that when you return from work, your stove is still hot and your home is warm.

**70% turn down** Fine-tuned automatic airflow, as our thermostat and catalyst work in tandem, allows you to turn down your Blaze King catalytic stove by up to 70%. Non Blaze King stoves only turn down by 33% and have little control over their heat output. Because of this most people use expensive electric heat in the spring and fall because they cannot control the heat output of their secondary air wood stove.

With a 70% turn down ability a Blaze king is perfect to heat your home in the shoulder season saving you money on heating costs.

**Easy to operate** Light a fire as per the instructions in your owner's manual. After you have established a good fire and the thermometer needle is well into the active zone

simply select your heat setting. Your Blaze King will now automatically control the heat from your stove until you need to load it again, which could be up to 40 hours later depending on the model you selected.

**Burn 33% less wood** The combination of our exclusive thermostat and catalytic combustor technology makes your Blaze King stove one of the most efficient wood stoves in the world. The proof of this is in our flue temperatures. Non Blaze King stoves have flue temperatures of between 600° F and 900° F while your Blaze King flue temperatures are between 150° F and 300° F. Non Blaze King stoves pump valuable heat up the flue. Your Blaze King catalytic stove keeps the heat in your home saving you money. By making your stove this efficient you will burn up to 33% less wood, cut, stack, load and clean 33% less wood. This is a major advantage that only a Blaze King offers.

**Less Cleaning** All Blaze King stove's produce very fine ash because we extract every last drop of energy from the wood. As a result you can go for very long periods before you have to empty your stove.

**Door Design** Every Blaze King has a steel frame around the door opening. Not only does this add strength to the firebox, but it creates a tight seal as it is pressed into the door gasket. Our engineers built the door latch so it is adjustable. You can adjust the tension on the gasket thus reducing the need for expensive replacements. The latch is also more durable because it is placed on the outside of the firebox.

**Lower Install Costs** Most non-Blaze King stoves require a thermal hearthpad. All Blaze King stoves only require spark protection which can save you hundreds of dollars on your install.



 **10 Year Extended Warranty**  
Because we believe in the technology and craftsmanship built into every Blaze King stove, we are proud to offer a 10 year 100% extended warranty on your catalytic combustor.

**E&OE.** Every effort is made to present accurate information in this brochure. Brochures are for marketing purposes and subject to change without notice. Please consult your owners manual prior to any installation.

Q.372  
7-2020



We endorse  
**NATIONAL  
FIREPLACE  
INSTITUTE**

**HPBA**  
Hearth, Patio & Barbecue Association